



USER'S GUIDE

V:0927-0713-11



KC222S

MP3-Ready Under Cabinet CD/Radio

For the most up-to-date version of this User's Guide, go to www.gpx.com

Warnings and Precautions

- **CAUTION:** TO PREVENT ELECTRIC SHOCK, MATCH WIDE BLADE OF PLUG TO WIDE SLOT, FULLY INSERT.
- **WARNING:** To reduce the risk of fire or electric shock, do not expose this apparatus to rain or moisture.
- **AVERTISSEMENT:** Pour réduire le risque d'incendie ou de choc électrique, ne pas exposer cet appareil sous la pluie et l'humidité.
- **CAUTION:** Use of any controls or adjustments or performance of procedures other than those herein specified may result in hazardous radiation exposure.
- **WARNING:** Changes or modifications to this unit not expressly approved by the party responsible for compliance could void the user's authority to operate the equipment.
- **WARNING:** Do not place the unit on top of any soft, porous, or sensitive surfaces to avoid damaging the surface. Use a protective barrier between the unit and surface to protect the surface.
- **WARNING:** Use of this unit near fluorescent lighting may cause interference regarding use of the remote. If the unit is displaying erratic behavior move away from any fluorescent lighting, as it may be the cause.
- **CAUTION:** Danger of explosion if battery is incorrectly replaced. Replace only with the same or equivalent type.
- **PRÉCAUTION:** *Danger d'explosion si les piles sont remplacées de façon incorrect. Remplacer les piles seulement par le même type de pile ou l'équivalent.*
- **WARNING:** The battery, batteries, and battery pack shall not be exposed to excessive heat such as sunshine, fire, or the like.
- **WARNING:** Lithium batteries, like all rechargeable batteries are recyclable and should be recycled or disposed of in normal household waste. Contact your local government for disposal or recycling practices in your area. They should never be incinerated since they might explode.

- **WARNING:** Shock hazard - Do Not Open.
- **AVIS:** *RISQUE DE CHOC ÉLECTRIQUE - NE PAS OUVRI*

Mains Plug or Direct plug-in adapter is used as disconnect device and it should remain readily operable during intended use. In order to disconnect the apparatus from the mains completely, the Mains Plug or Direct plug-in adapter should be disconnected from the mains socket outlet completely.

La fiche d'alimentation ou adaptateur de courant est utilisé comme dispositif de déconnexion et doit rester accessible pendant l'utilisation. Pour mettre l'appareil hors tension, la fiche ou adaptateur de courant doit être débranché de la prise de courant.

Do not mix old and new batteries.

Do not mix alkaline, standard (carbon-zinc), or rechargeable (ni-cad, ni-mh, etc) batteries.

No mezcle baterías viejas y nuevas.

No mezcle baterías alcalinas, estándar (carbono-zinc) o recargables (ni-cad, ni-mh, etc.).



WARNING: TO REDUCE THE RISK OF ELECTRIC SHOCK, DO NOT REMOVE COVER (OR BACK). NO USER-SERVICEABLE PARTS INSIDE. REFER SERVICING TO QUALIFIED SERVICE PERSONNEL.



The lightning flash with arrowhead symbol, within an equilateral triangle, is intended to alert the user to the presence of uninsulated "dangerous voltage" within the product's enclosure that may be of sufficient magnitude to constitute a risk of electric shock to persons.



The exclamation point within an equilateral triangle is intended to alert the user to the presence of important operating and maintenance (servicing) instructions in the literature accompanying the appliance.



This product utilizes a Class 1 laser to read Compact Discs. This laser Compact Disc Player is equipped with safety switches to avoid exposure when the CD door is open and the safety interlocks are defeated. Invisible laser radiation is present when the CD Player's lid is open and the system's interlock has failed or been defeated. It is very important that you avoid direct exposure to the laser beam at all times. Please do not attempt to defeat or bypass the safety switches.

Important Safety Instructions

1. Read these Instructions.
 2. Keep these Instructions.
 3. Heed all Warnings.
 4. Follow all instructions.
 5. Do not use this apparatus near water.
 6. Clean only with a dry cloth.
 7. Do not block any ventilation openings. Install in accordance with the manufacturer's instructions.
 8. Do not install near any heat sources such as radiators, heat registers, stoves, or other apparatus (including amplifiers) that produce heat.
 9. Do not defeat the safety purpose of the polarized or grounding - type plug. A polarized plug has two blades with one wider than the other. A grounding type plug has two blades and a third grounding prong. The wide blade or the third prong are provided for your safety. When the provided plug does not fit into your outlet, consult an electrician for replacement of the obsolete outlet.
 10. Protect the power cord from being walked on or pinched particularly at plugs, convenience receptacles, and the point where they exit from the apparatus.
 11. Only use attachments/accessories specified by the manufacturer.
-
12.  Use only with a cart, stand, tripod, bracket, or table specified by the manufacturer, or sold with the apparatus. When a cart is used, use caution when moving the cart/apparatus combination to avoid injury from tip-over.
-
13. Unplug this apparatus during lightning storms or when unused for long periods of time.
 14. Refer all servicing to qualified service personnel. Servicing is required when the apparatus has been damaged in any way, such as power-supply cord or plug is damaged, liquid has been spilled or objects have fallen into the apparatus, the apparatus has been exposed to rain or moisture, does not operate normally, or has been dropped.

Special note: When placing your unit on a lacquered or natural finish, protect your furniture with a cloth or other protective material.

FCC Warnings

WARNING: Changes or modifications to this unit not expressly approved by the party responsible for compliance could void the user's authority to operate the equipment.

NOTE: This equipment has been tested and found to comply with the limits for a Class B digital device, pursuant to Part 15 of the FCC Rules. These limits are designed to provide reasonable protection against harmful interference in a residential installation. This equipment generates, uses, and can radiate radio frequency energy and, if not installed and used in accordance with the instructions, may cause harmful interference to radio communications. However, there is no guarantee that interference will not occur in a particular installation. If this equipment does cause harmful interference to radio or television reception, which can be determined by turning the equipment off and on, the user is encouraged to try to correct the interference by one or more of the following measures:

- Reorient or relocate the receiving antenna.
- Increase the separation between the equipment and receiver.
- Connect the equipment into an outlet on a circuit different from that to which the receiver is connected.
- Consult the dealer or an experienced radio/TV technician for help.

Additional Warnings

- The apparatus shall not be exposed to dripping or splashing and that no objects filled with liquids, such as vases, shall be placed on apparatus.
L'appareil ne doit pas être exposé aux écoulements ou aux éclaboussures et aucun objet ne contenant de liquide, tel qu'un vase, ne doit être placé sur l'objet.
- Battery shall not be exposed to excessive heat such as sunshine, fire or the like.
Les piles ne doivent pas être exposées à de forte chaleur, tel qu'à la lumière du soleil, au feu ou autres choses de semblable.
- Caution marking is located at the rear or bottom of the apparatus.
Attention marquage est situé sur le panneau arrière ou inférieur de l'unité.
- The marking information is located at the rear or bottom of apparatus.
Le marquage est situé sur le panneau arrière ou inférieur de l'unité.



This symbol indicates that this product incorporates double insulation between hazardous mains voltage and user accessible parts.

MP3-Ready Under Cabinet CD/Radio

Features

- CD player: CD, CD-R/RW
- AM/FM radio
- Flip down MP3 cradle
- Line input
- LCD display
- Dynamic speakers
- Digital clock
- Kitchen Timer
- Magnetic remote control
- Easy-clean front surface
- FM wire antenna
- AC power: built-in AC power cable

Included

- Remote control: Requires 1 CR2025 battery (pre- installed)
- Mounting template
- Mounting screws
- Mounting spacers

Table of Contents

MP3-Ready Under Cabinet CD/Radio	4
Features	
Included	
Table of Contents	5
Introduction	6
Setup	8
Power	
Remote	
Battery Backup	
Mounting	
Clock	9
Setting the Clock	
Setting the Timer	
Setting the Alarm	
CD and Radio	10
Loading a CD	
Programming a CD	
Tuning the Radio	
Saving a Station as a Preset	
Tuning Preset Radio Stations	
Connecting an MP3 Device	11
Connecting an MP3 Device	
Playing Audio from the MP3 Device	
Company Information	12
International Support	
Contact Information	
Green Initiative	

Introduction

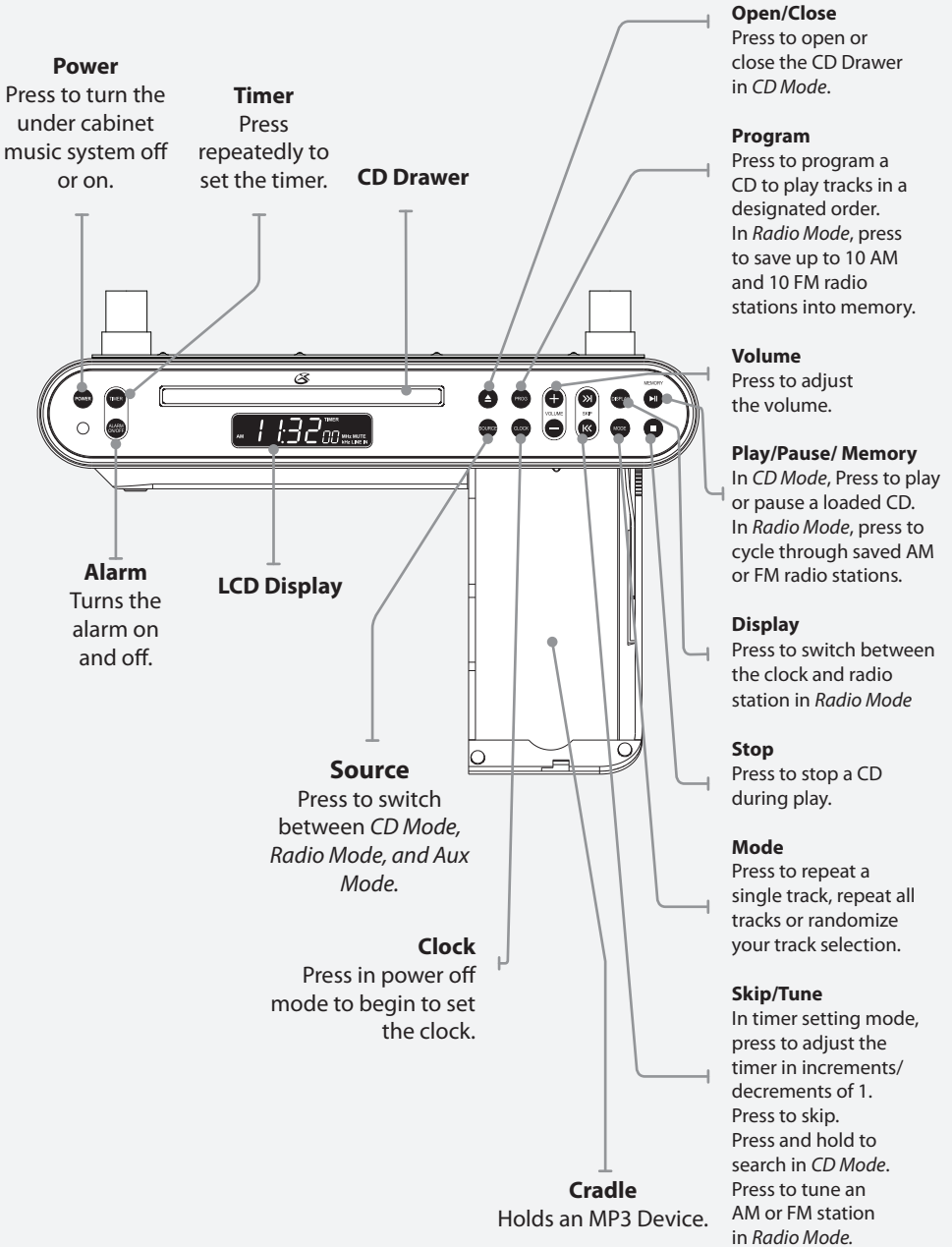

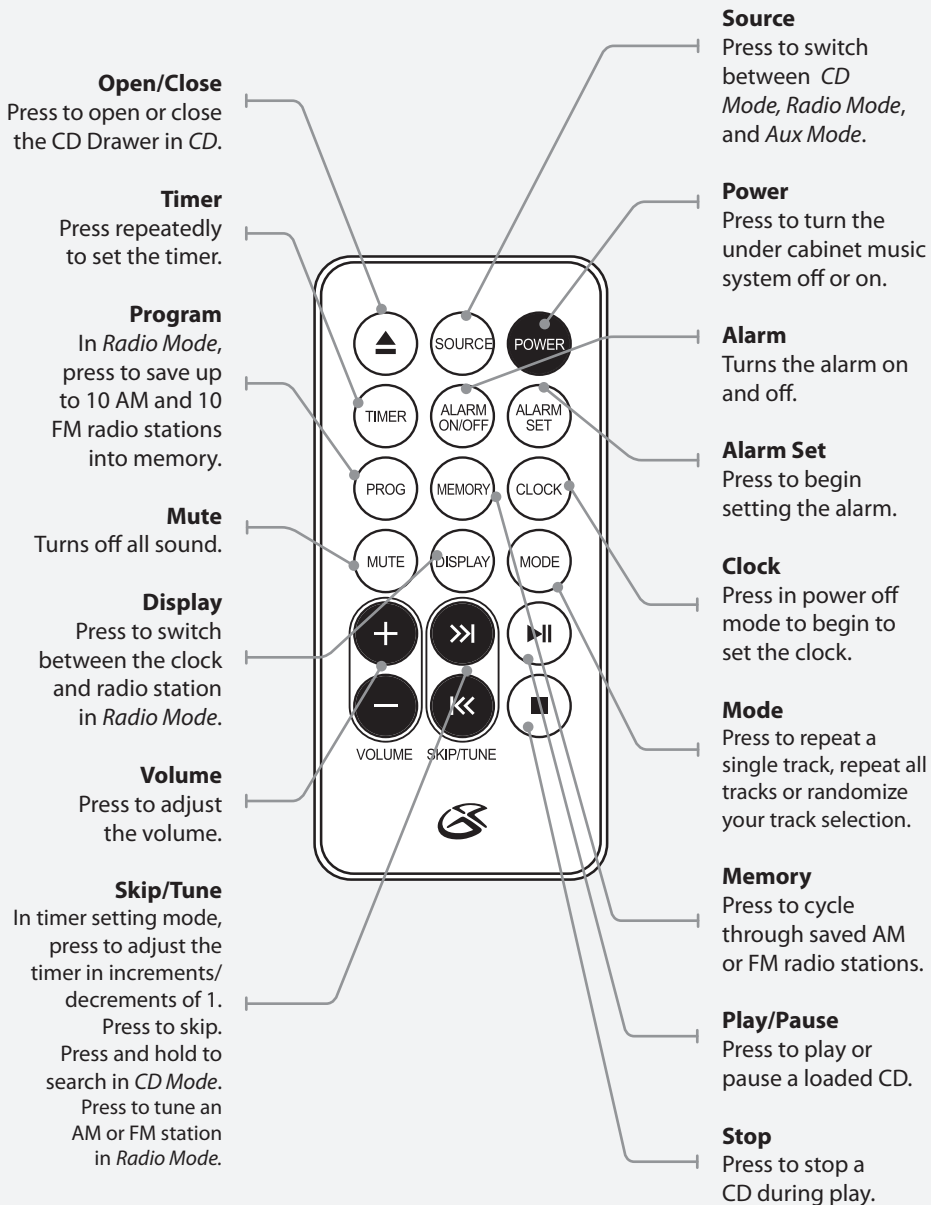

Setup

Power

Plug the attached AC cord into a standard AC power outlet to power the unit.

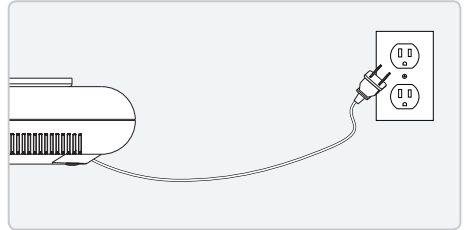

Remote

Requires 1 CR2025 battery (pre- installed)

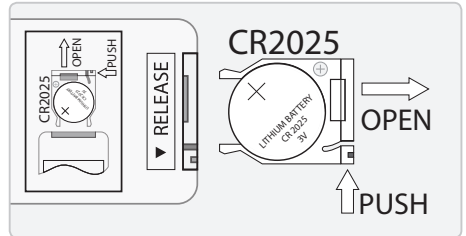

Battery Backup

Requires 2 AAA batteries (not included)

The battery backup is designed for short-term unexpected power outages. Under these circumstances, the time and alarm settings will be saved. The music system cannot power primary functions such as the radio.

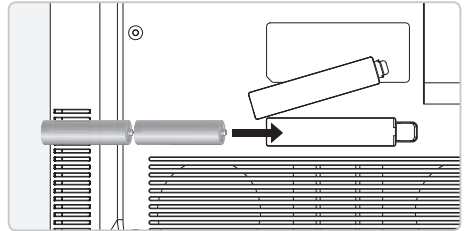

Mounting

A mounting template, which contains mounting instructions, is included in the packaging.

IMPORTANT: You should only use the mounting accessories included with this under cabinet music system when attempting to mount it under a cabinet. Use of unapproved accessories that have not been designed specifically for this unit could lead to safety hazards.

WARNING: The remote control's button cell battery contains mercury. Do not put in the trash, instead recycle or dispose of as hazardous waste.

Clock

Setting the Clock

1. In power off, press and hold the **Clock** button.
The hour on the display will begin blinking.
2. Press the **Skip/Tune** buttons to adjust the hour.
3. Press the **Clock** button.
The minutes on the display will begin blinking.
4. Press the **Skip/Tune** buttons to adjust the minutes.
5. Press the **Clock** button to finish setting the time.

Setting the Timer

1. Press the **Timer** button repeatedly to adjust the timer in increments of 10 min
Ex. 180, 170 or OFF.
2. Press the **Skip/Tune** buttons to adjust the timer in increments/ decrements of 1 min.
3. After the set time has expired, the under cabinet music system will sound an alarm.
4. To cancel the alarm after it has sounded, press the **Power** button.
5. To cancel the timer before the alarm has sounded, press the **Timer** button repeatedly until it is set to OFF

Setting the Alarm

1. In power off, press and hold the **Alarm Set** button.
The hour on the display will begin blinking.
2. Press the **Skip/Tune** buttons to adjust the hour.
3. Press the **Alarm Set** button.
The minutes on the display will begin blinking.
4. Press the **Skip/Tune** buttons to adjust the minutes.
5. Press the **Alarm Set** button.
6. Press the **Skip/Tune** button to select the alarm source.
CD, AM, FM or Buzzer.
7. Press the **Alarm Set** button.
8. To turn the alarm off, press the **Alarm On/Off** button.
9. To cancel the alarm before the alarm has sounded, press the **Alarm On/Off** button.

CD and Radio

Loading a CD

1. Press the **Power** button to turn the under cabinet music system on.
2. Press the source button to switch to *CD Mode*.
3. Press the **Open/Close** button to open the CD drawer.
4. Load a CD into the CD drawer, label side facing up.
5. Once the CD is loaded, the CD should start playing automatically.
6. If the CD does not start playing automatically, press the **Play/Pause** button.

Programming a CD

1. Follow the instructions for Loading A CD.
2. Press the **Stop** button.
3. Press the **Prog** button.
"01", indicating the current program track, will begin flashing on the display.
4. Press the **Skip/Tune** buttons to select the CD track you would like to play in the program.
5. Press the **Prog** button.
6. Repeat steps 3, 4, and 5 to continue programming CD tracks.
Up to 20 tracks can be programmed.
7. Press the **Play/Pause** button to begin playing the programmed CD.
8. To cancel a program, press the **Stop** button twice.

Tuning the Radio

1. Press the **Power** button to turn the under cabinet music system on.
2. Press the **Source** button to switch to AM or FM *Radio Mode*.
Radio Mode is indicated by "AM" or "FM" on the display.
3. Press the **Skip/Tune** button to tune the AM or FM radio.
4. Hold down the **Skip/Tune** button to scan for the next available station.

Saving a Station as a Preset

1. Follow the instructions for Tuning the Radio.
2. Tune to the desired station.
3. Press the **Prog** button.
4. Preset number will appear on the display.
5. Press the **Skip/Tune** buttons to adjust to the desired preset number.
6. Press the **Prog** button to save the current radio station to the selected preset.

Tuning Preset Radio Stations

1. Follow the instructions for Tuning the Radio and Saving a Station as a Preset.
2. Press the **Memory** button to cycle through preset radio stations

Connecting an MP3 Device

Connecting an MP3 Device

1. Slide the release button located on the bottom of the unit and the **Cradle** will extend downward.
2. Place an MP3 Device into the **Cradle**.
3. Connect the **Line Input Cable** to the headphone jack on an MP3 Device.
4. Press the **Source** button to switch to *AUX Mode*.

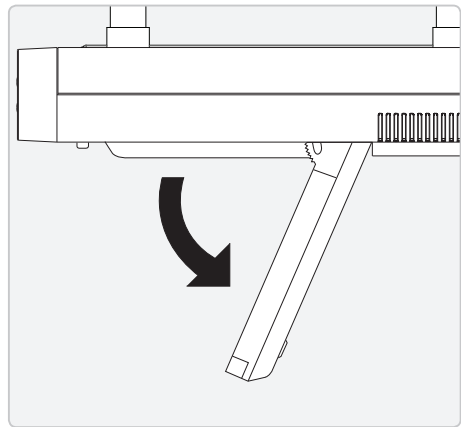
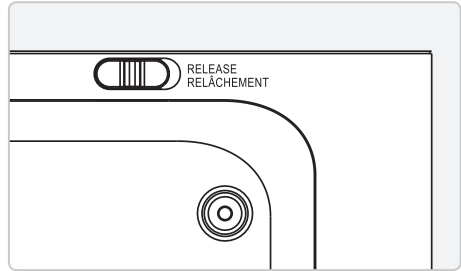

Playing Audio from the MP3 Device

1. Follow the instructions for [Connecting An MP3 Device](#)
2. Press the **Power** button to turn the under cabinet music system on.
3. Press the **Source** button to switch to *AUX Mode*.
AUX Mode is indicated by "AUX" on the display.
4. Use the native controls on the connected MP3 Device to play music.

Company Information

International Support

To download this User's Guide in English, Spanish, or French, visit the support section at www.gpx.com.

Para transferir esta guía de usuario en inglés, español, o francés, visite la sección de la ayuda en www.gpx.com.

Pour télécharger ce guide de l'utilisateur en anglais, espagnol, ou français, visitez la section de soutien chez www.gpx.com.

Contact Information

Phone: 1-888-999-4215

Email: prodinfo@gpx.com

Parts Email: partsinfo@dpi-global.com

Website: www.gpx.com

Green Initiative



Environmental Commitment to 'Protect for Today and Sustain for Tomorrow'

2009 marked the official launch of DPI, Inc.'s corporate campaign for a greener and cleaner world. DPI is building upon environmental initiatives introduced at all of their facilities to help formulate and sustain significant and important conservation efforts within its manufacturing and marketing communities. In addition to targeting and selecting energy efficient product features, and structuring 'green office' procedures, other initial program efforts include:

- Reduction of all packaging sizes
- Recyclable plastics for clamshell packages, with a plan to eventually replace plastic with recyclable paper
- Recycled fiber board in place of the polyfoam in packing boxes
- Recycled plastics in place of the virgin material in product construction